

# LÆS OG FORSTÅ

## ORD - BOG 5







	Ja	Nej
ble		
bål		
fe		

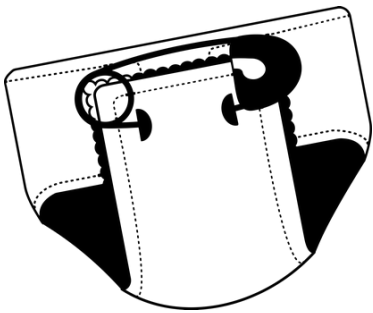

	Ja	Nej
bus		
blå		
ble		



	Ja	Nej
bål		
gul		
fe		

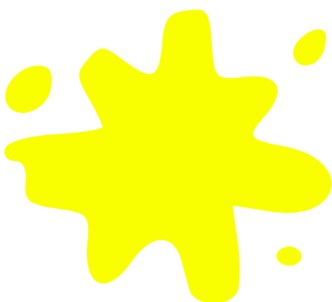

	Ja	Nej
gul		
blå		
grå		



ble



blå

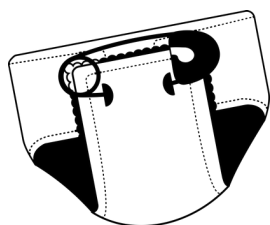

bål

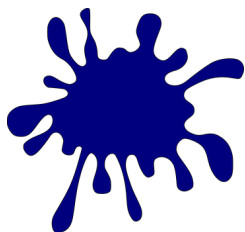

fly

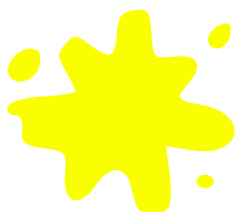

gul



fe



skriv ordet



fe

\_\_\_\_\_



bål

\_\_\_\_\_

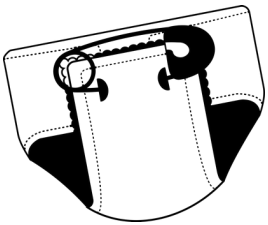

ble

\_\_\_\_\_

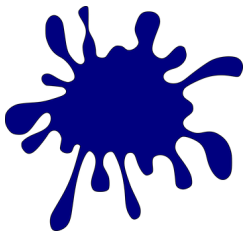

blå

\_\_\_\_\_

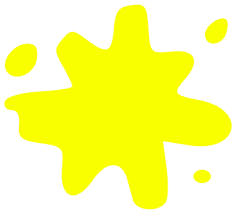

gul

\_\_\_\_\_



fly

\_\_\_\_\_



blå og blå

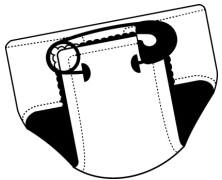

fe og bål

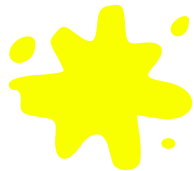

ble og fly

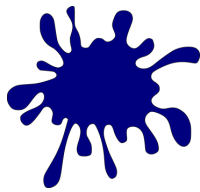
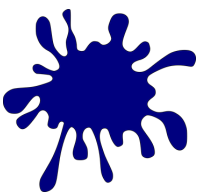

ble og fe

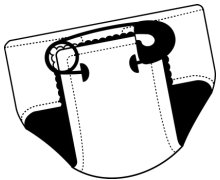

fly og gul

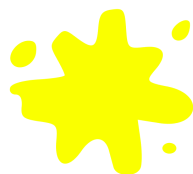

bål og gul

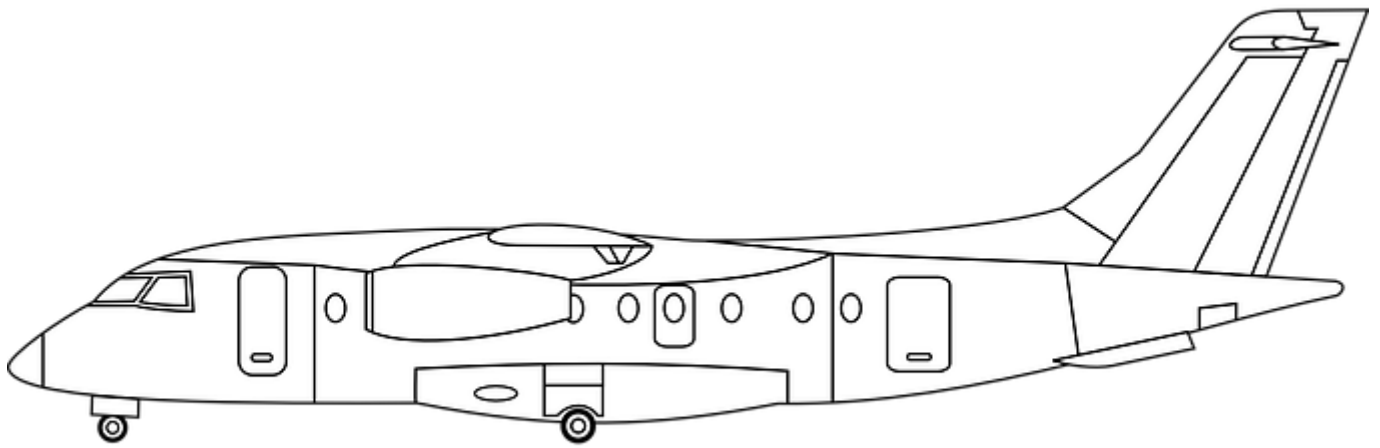
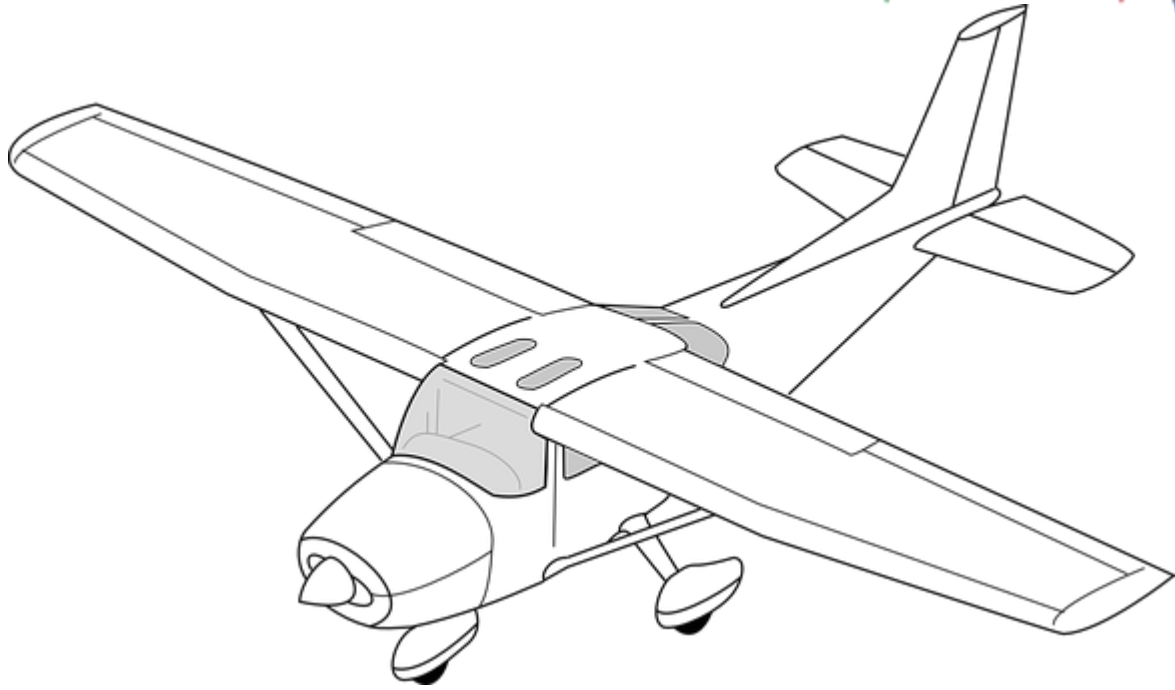

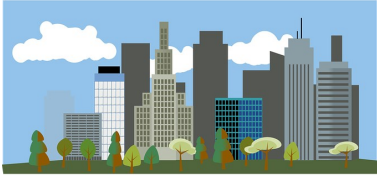

	Ja	Nej
bro		
by		
brun		



	Ja	Nej
bus		
grå		
bro		



	Ja	Nej
bus		
brun		
hus		



	Ja	Nej
hus		
bus		
by		



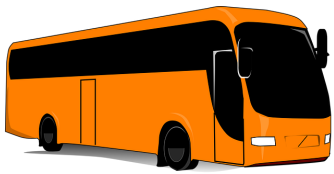

by

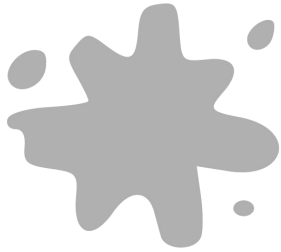

bro

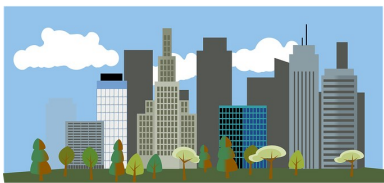

grå



hus



brun



bus

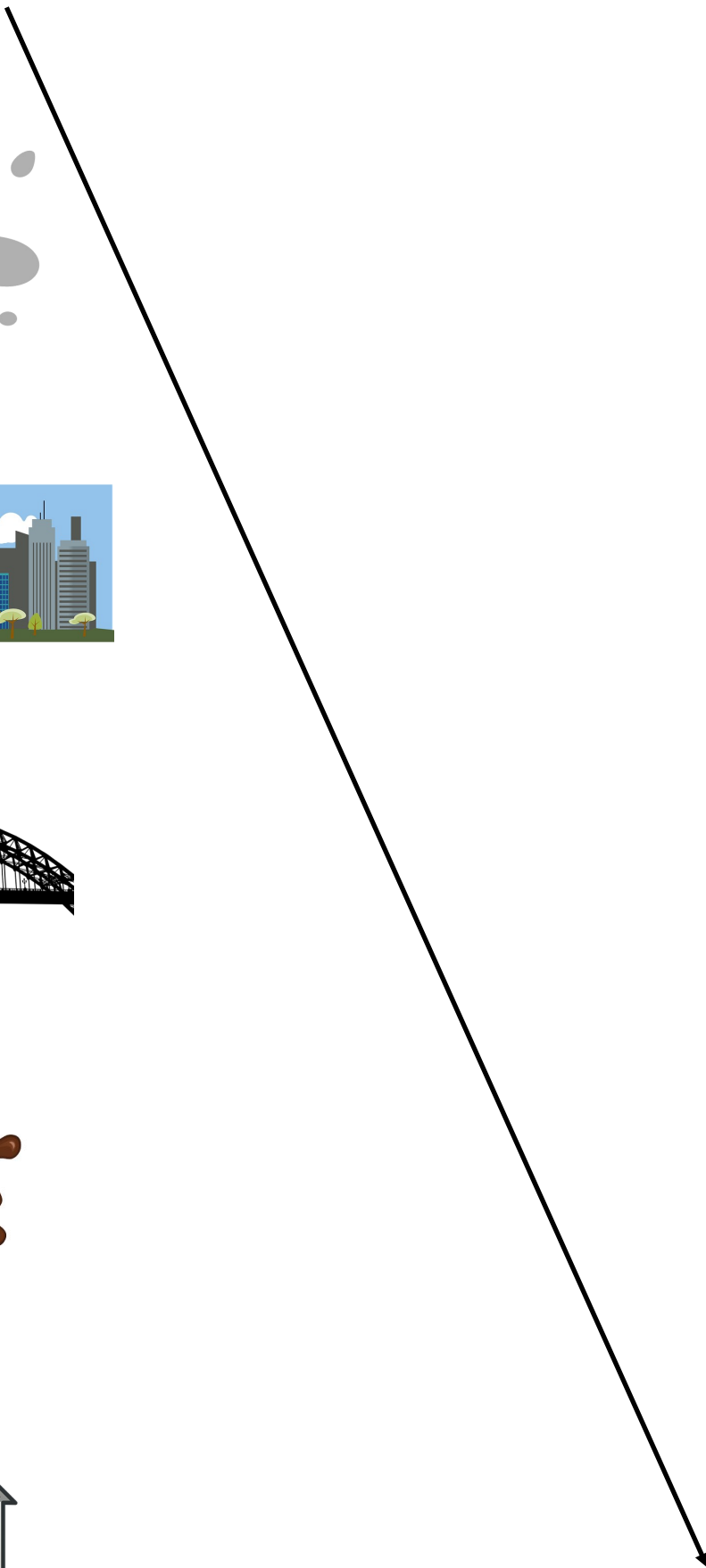

skriv  
ordet



bus

---



grå

---

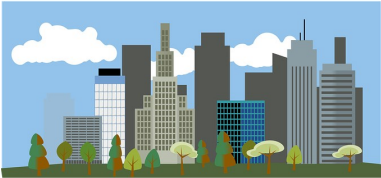

by

---



bro

---



brun

---



hus

---



brun og bus



by og brun



by og grå

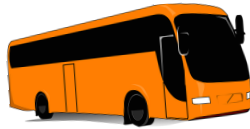

bus og hus

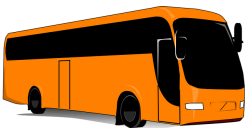

hus og bro



bro og grå

